

GAMIT Modeling Aspects

Lecture 04

Thomas Herring

tah@mit.edu

Challenges and Opportunities in GPS Measurements

- “One-sided” geometry increases vertical uncertainties relative to horizontal and makes the vertical more sensitive to session length
- For geophysical measurements the atmospheric delay and signal scattering are unwanted sources of noise
- For meteorological applications, the atmospheric delay due to water vapor is an important signal; the hydrostatic delay and signal scattering are sources of noise
- Loading of the crust by the oceans, atmosphere, and water can be either signal or noise
- Local hydrological uplift or subsidence can be either signal or noise
- Changes in instrumentation are to be avoided

BURN North Offset 4762193.218 m
rate(mm/yr)= 1.39 ± 0.04 nrms= 0.69 wrms= 1.5 mm # 1578

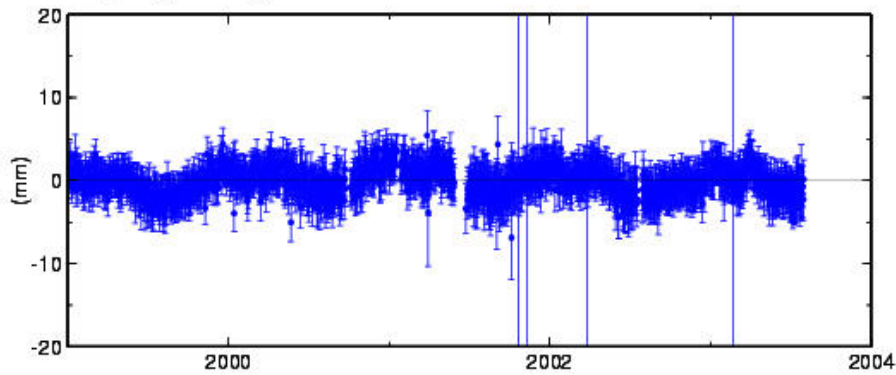

BURN East Offset 19785454.795 m
rate(mm/yr)= -1.43 ± 0.05 nrms= 0.86 wrms= 2.1 mm # 1578

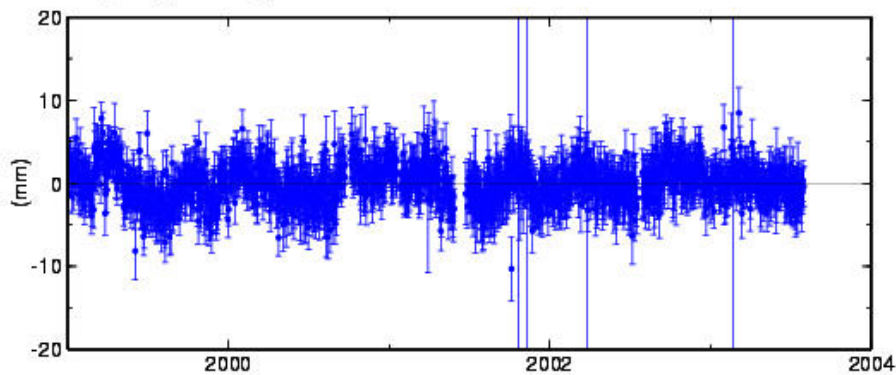

BURN Up Offset 1180.839 m
rate(mm/yr)= -1.62 ± 0.13 nrms= 0.79 wrms= 5.5 mm # 1578

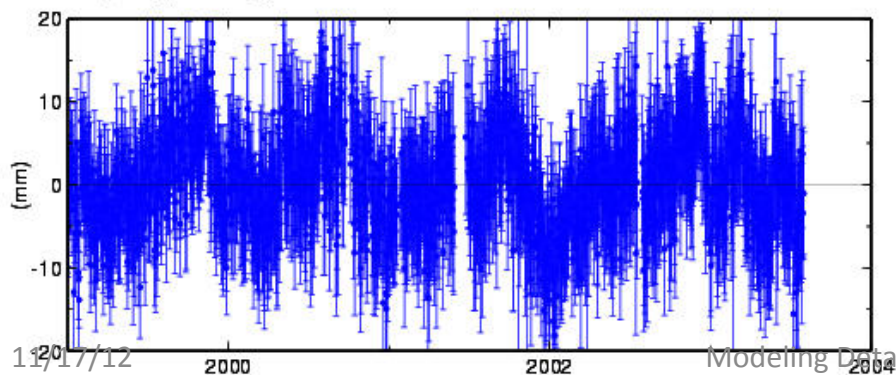

Time series for
continuous station in
(dry) eastern Oregon

Vertical wrms 5.5 mm,
higher than the best
stations. Systematics
may be atmospheric or
hydrological loading,
Local hydrology, or
Instrumental effects

Antenna Phase Patterns

AOA CR L1

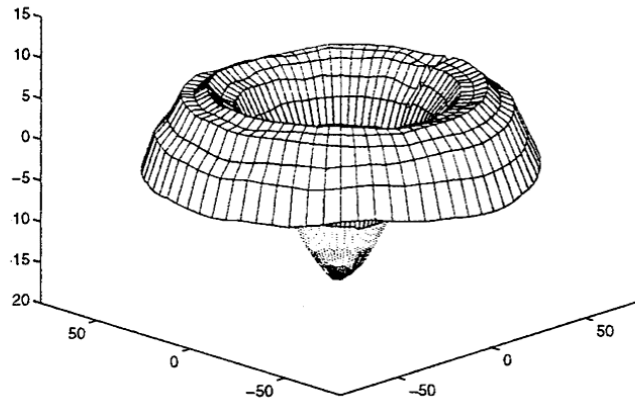

Leica L1

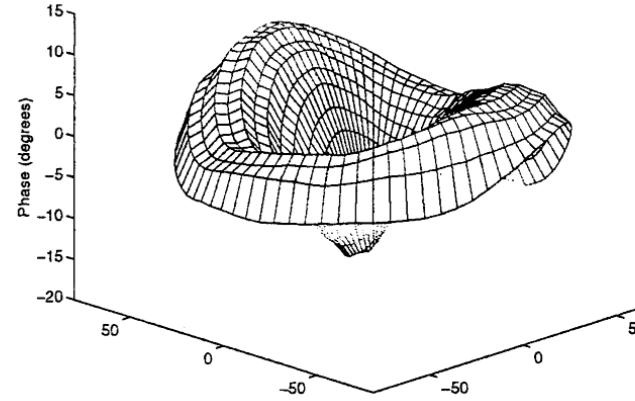

Ashtech CR L1

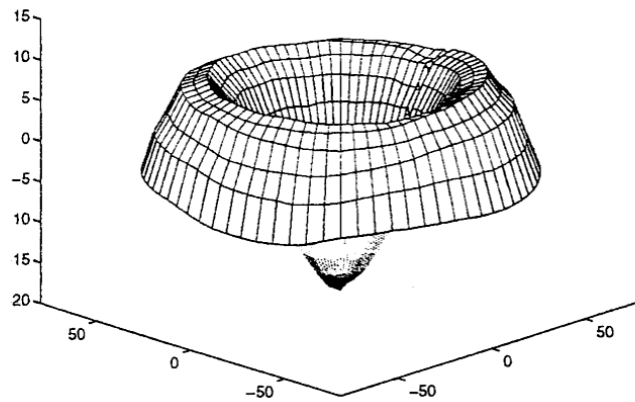

AOA Rascal L1

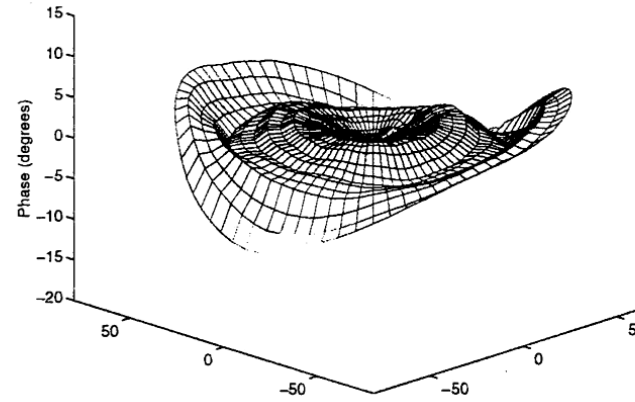

Modeling Antenna Phase-center Variations (PCVs)

- Ground antennas
 - Relative calibrations by comparison with a ‘standard’ antenna (NGS, used by the IGS prior to November 2006)
 - Absolute calibrations with mechanical arm (GEO++) or anechoic chamber
 - May depend on elevation angle only or elevation and azimuth
 - Current models are radome-dependent
 - Errors for some antennas can be several cm in height estimates
- Satellite antennas (absolute)
 - Estimated from global observations (T U Munich)
 - Differences with evolution of SV constellation mimic scale change
 - Recommendation for GAMIT: Use latest IGS absolute ANTEX file (absolute) with AZ/EL for ground antennas and ELEV (nadir angle) for SV antennas
 - (MIT file augmented with NGS values for antennas missing from IGS)

Multipath and Water Vapor Can be seen in the Phase Residuals

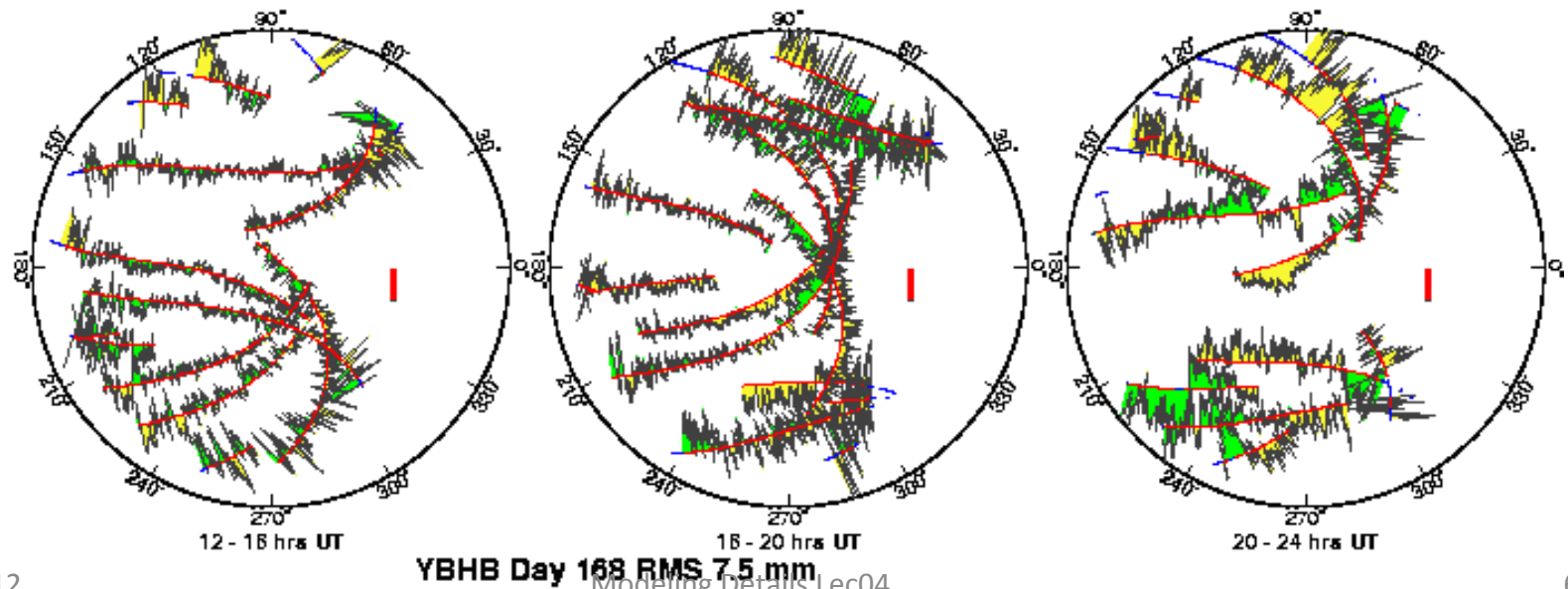
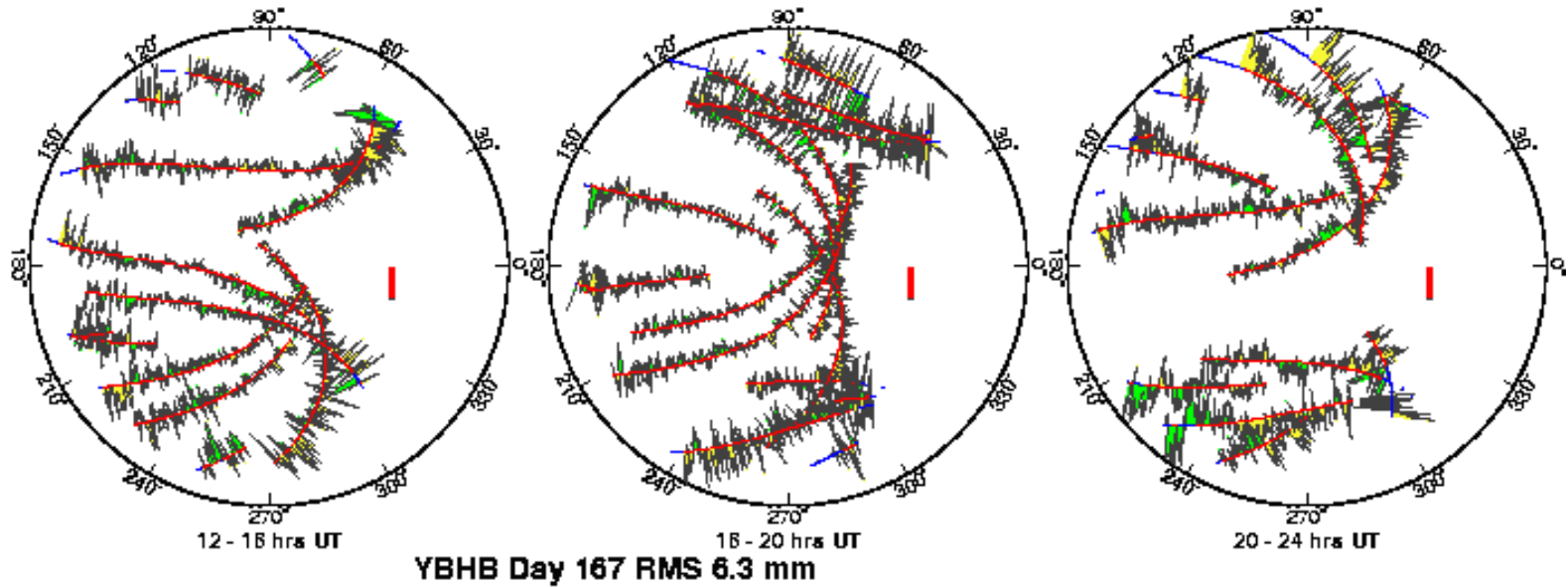

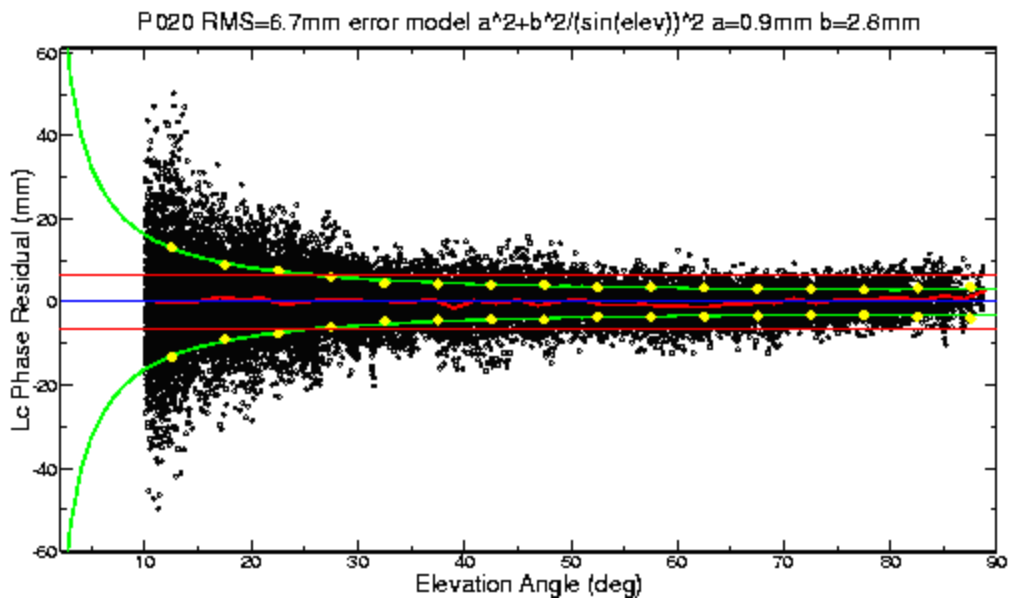

Top: PBO station near Lind, Washington.

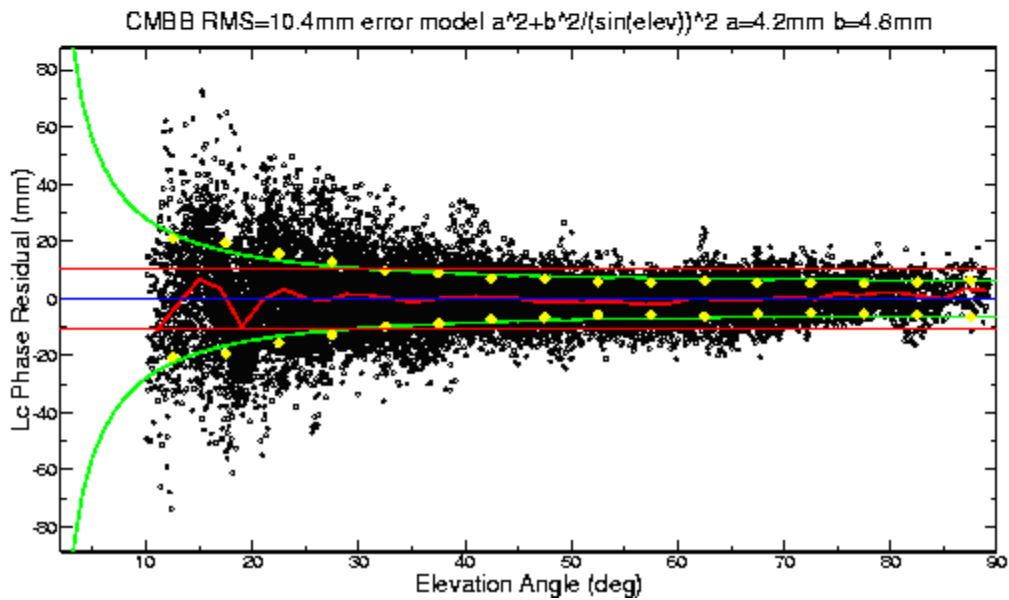

Bottom: BARD station CMBB at Columbia College, California

More examples

P473 RMS=4.7mm error model $a^2+b^2/(\sin(\text{elev}))^2$ $a=1.7\text{mm}$ $b=1.9\text{mm}$

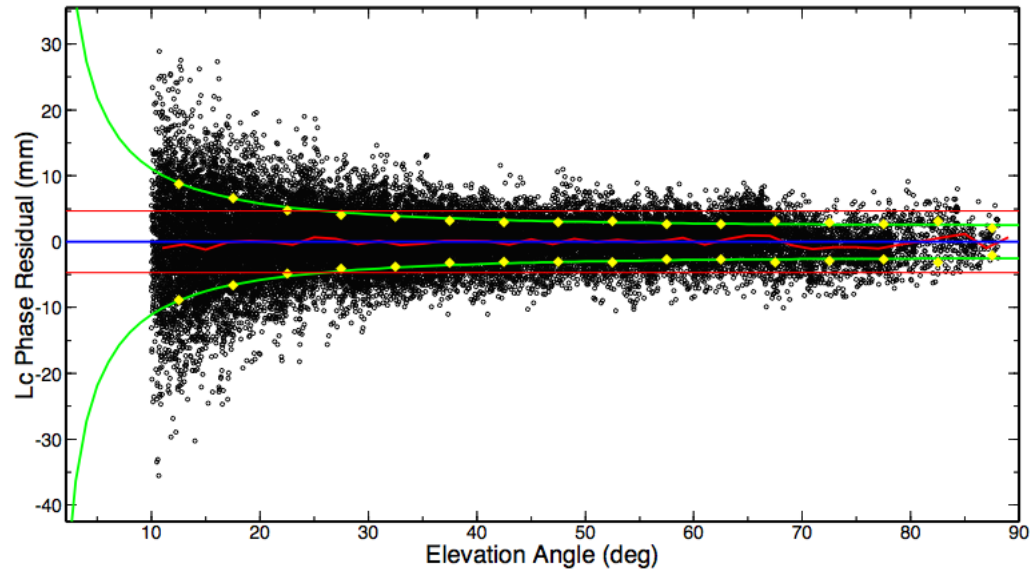

P501 RMS=8.0mm error model $a^2+b^2/(\sin(\text{elev}))^2$ $a=2.5\text{mm}$ $b=3.3\text{mm}$

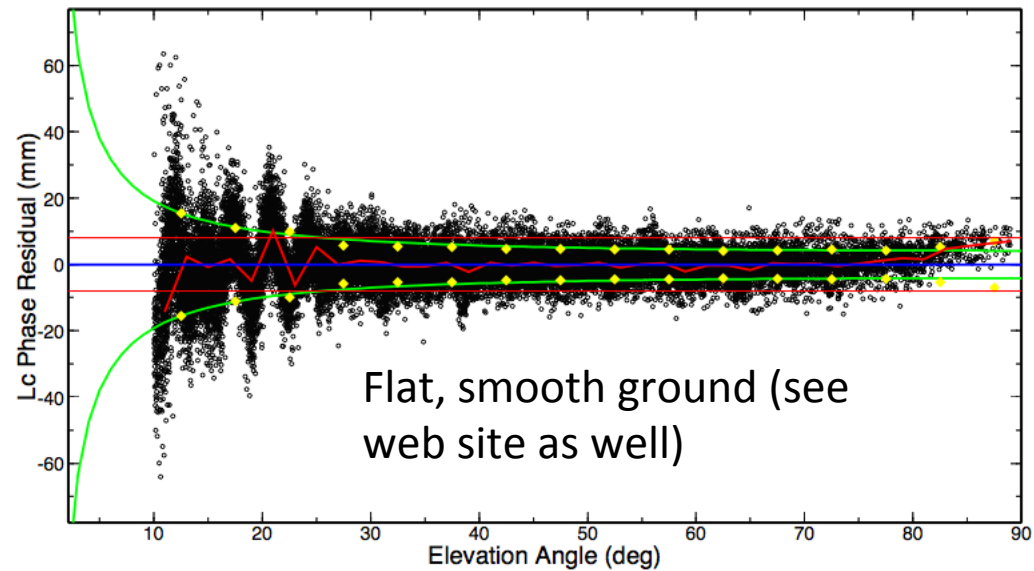

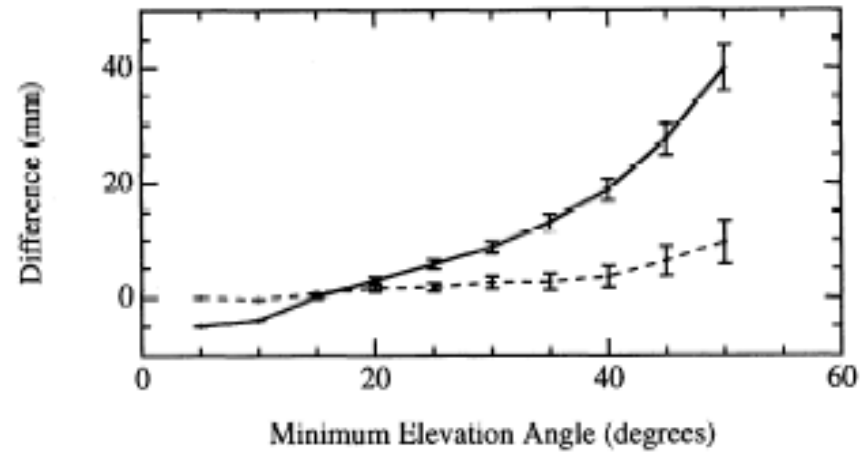
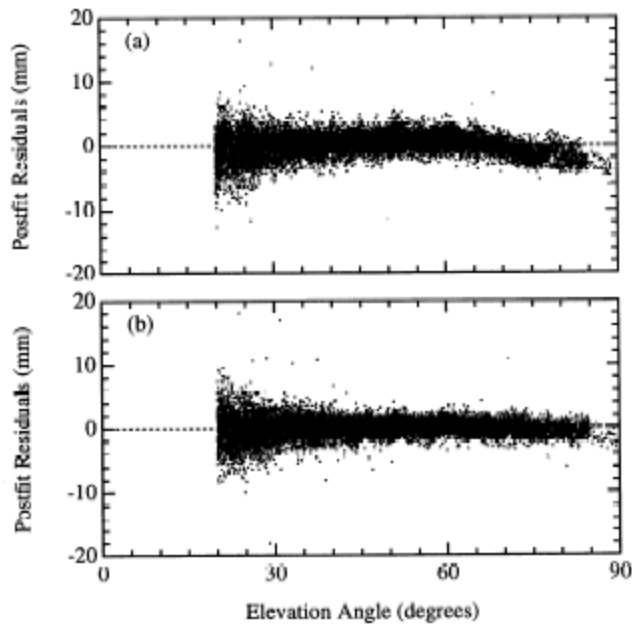

Left: Phase residuals versus elevation for Westford pillar, without (top) and with (bottom) microwave absorber.

Right: Change in height estimate as a function of minimum elevation angle of observations; solid line is with the unmodified pillar, dashed with microwave absorber added

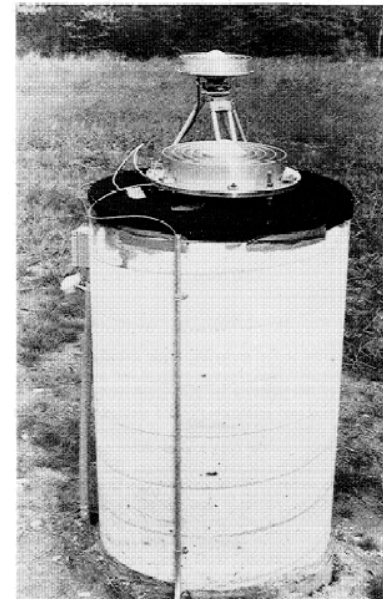

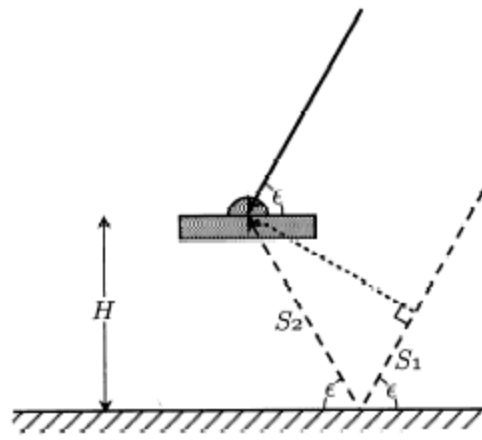

Simple geometry for incidence of a direct and reflected signal

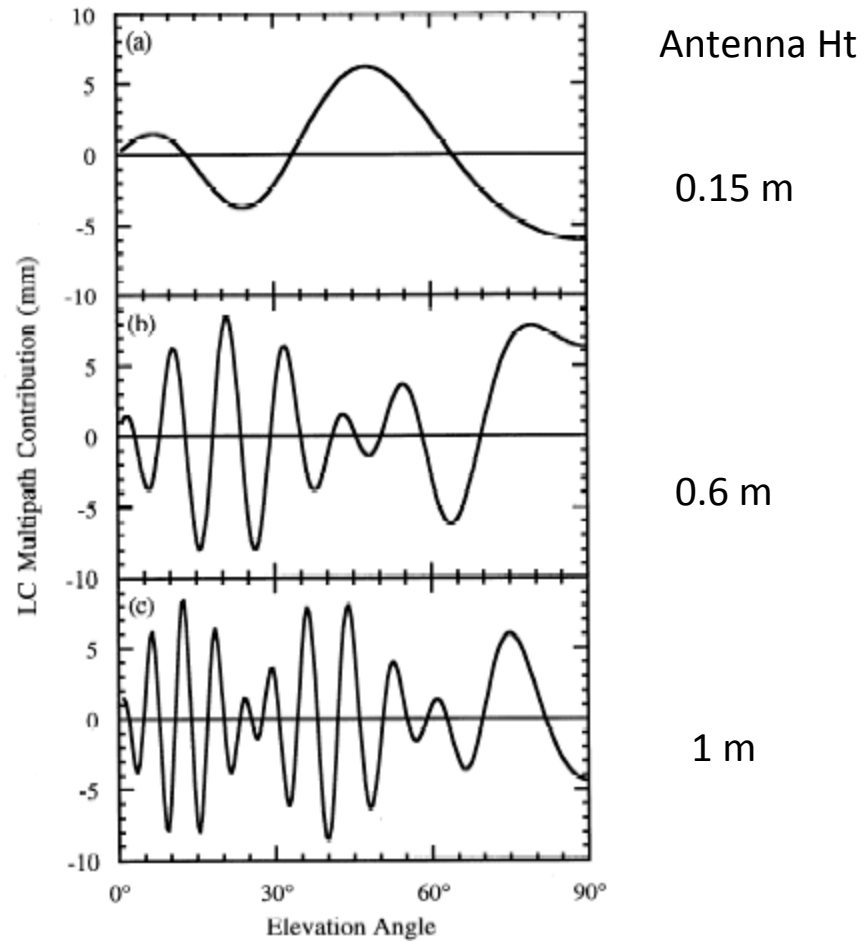

Multipath contributions to observed phase for three different antenna heights [From *Elosegui et al*, 1995]

Atmospheric Delay

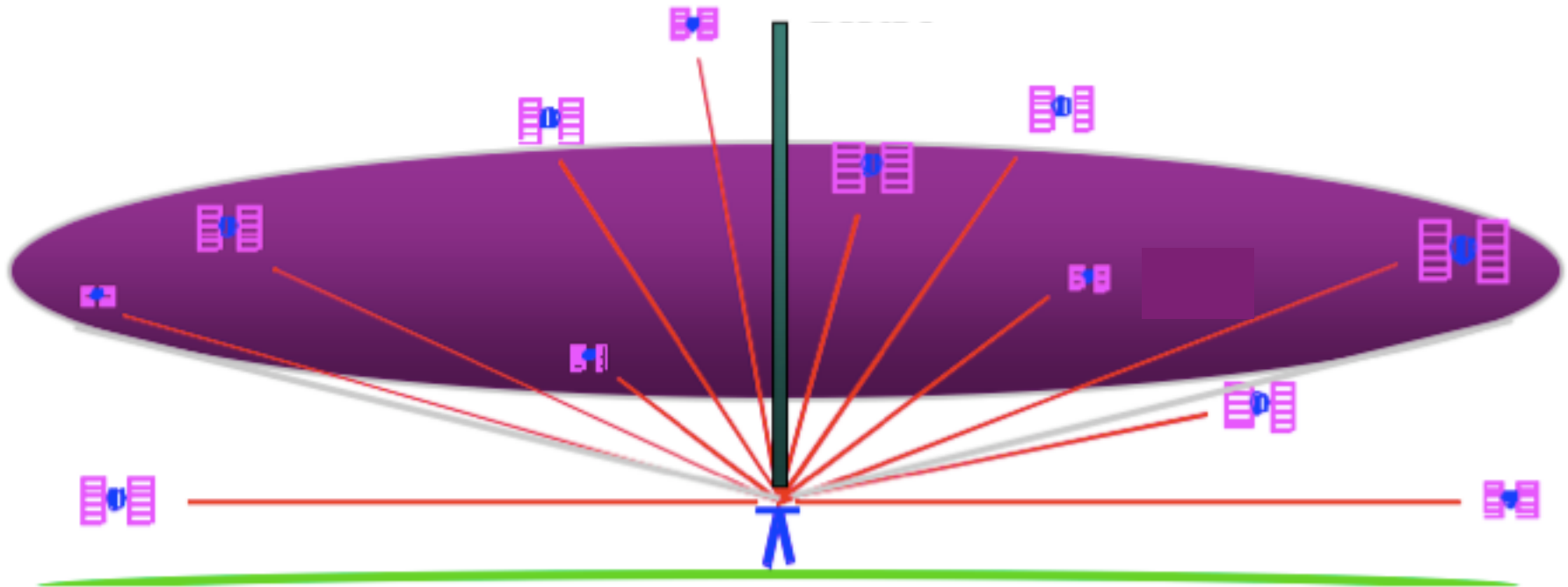

The signal from each GPS satellite is delayed by an amount dependent on the pressure and humidity and its elevation above the horizon. We invert the measurements to estimate the average delay at the zenith (green bar).

(Figure courtesy of COSMIC Program)

Zenith Delay from Wet and Dry Components of the Atmosphere

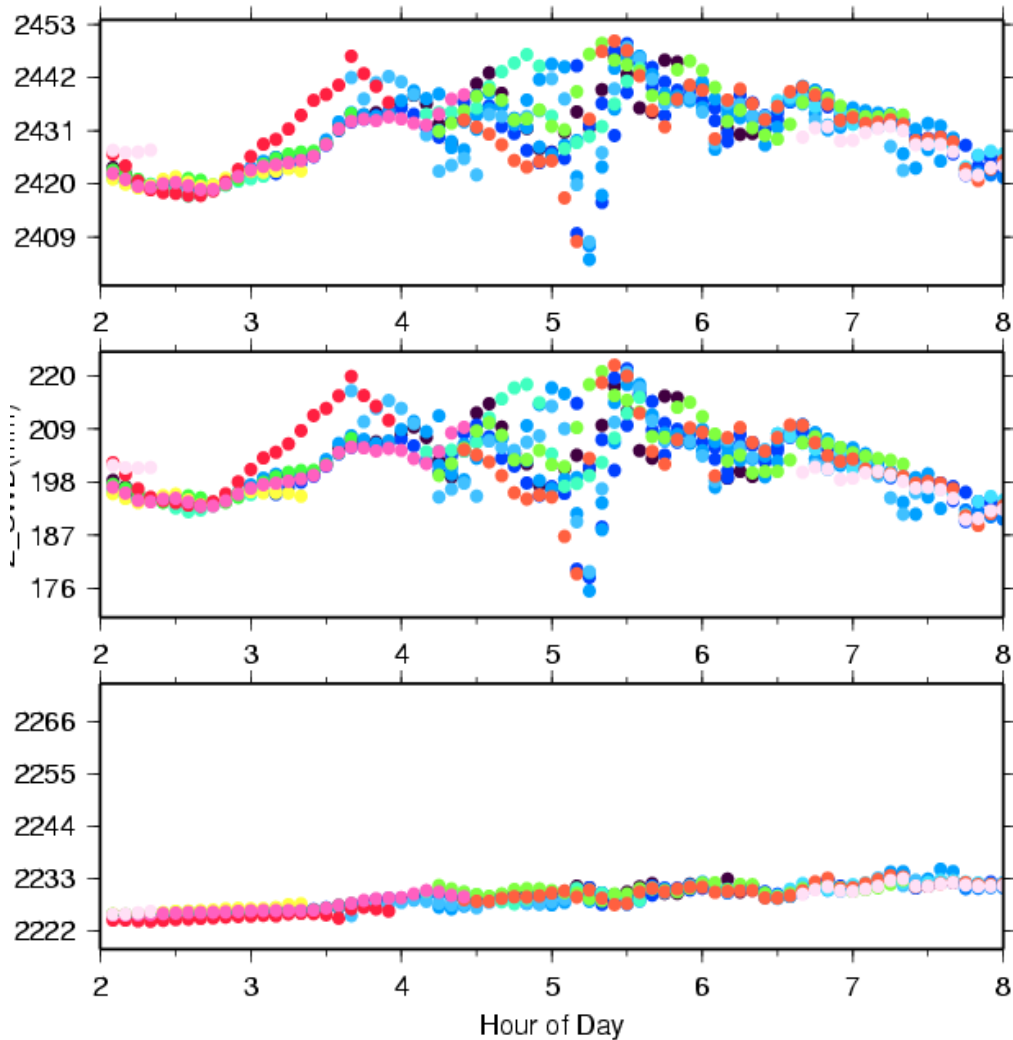

Colors are for different satellites

Total delay is ~2.5 meters
Variability mostly caused by wet component.

Wet delay is ~0.2 meters
Obtained by subtracting the hydrostatic (dry) delay.

Hydrostatic delay is ~2.2 meters; little variability between satellites or over time; well calibrated by surface pressure.

Plot courtesy of J. Braun, UCAR

Example of GPS Water Vapor Time Series

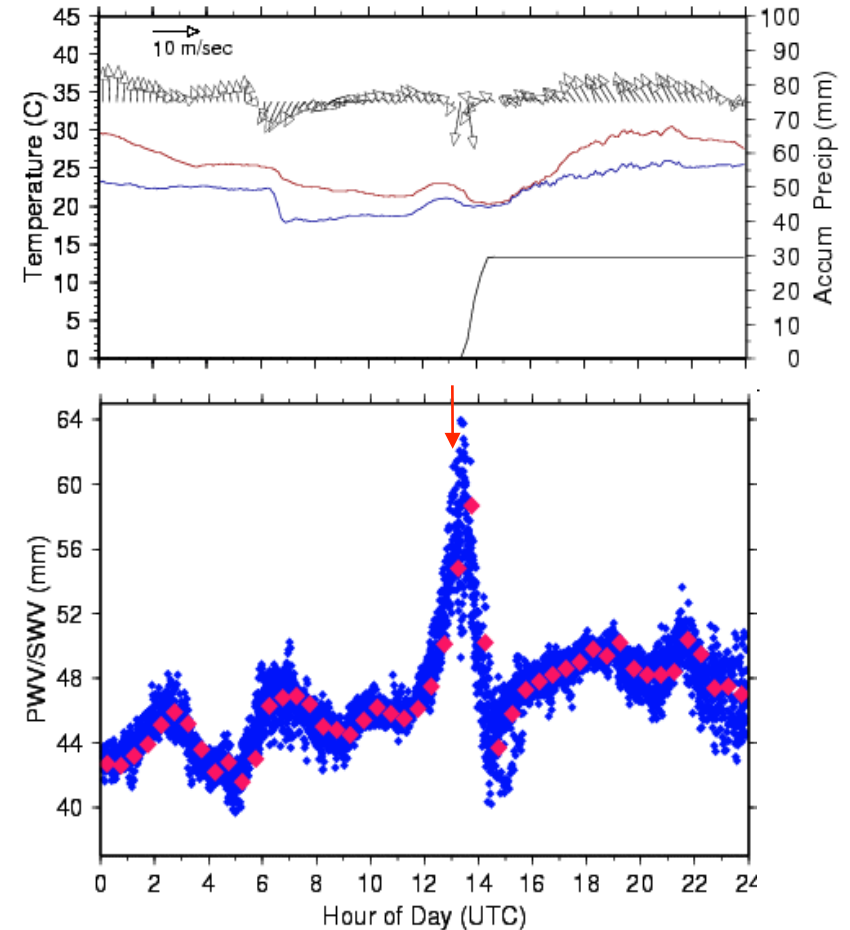
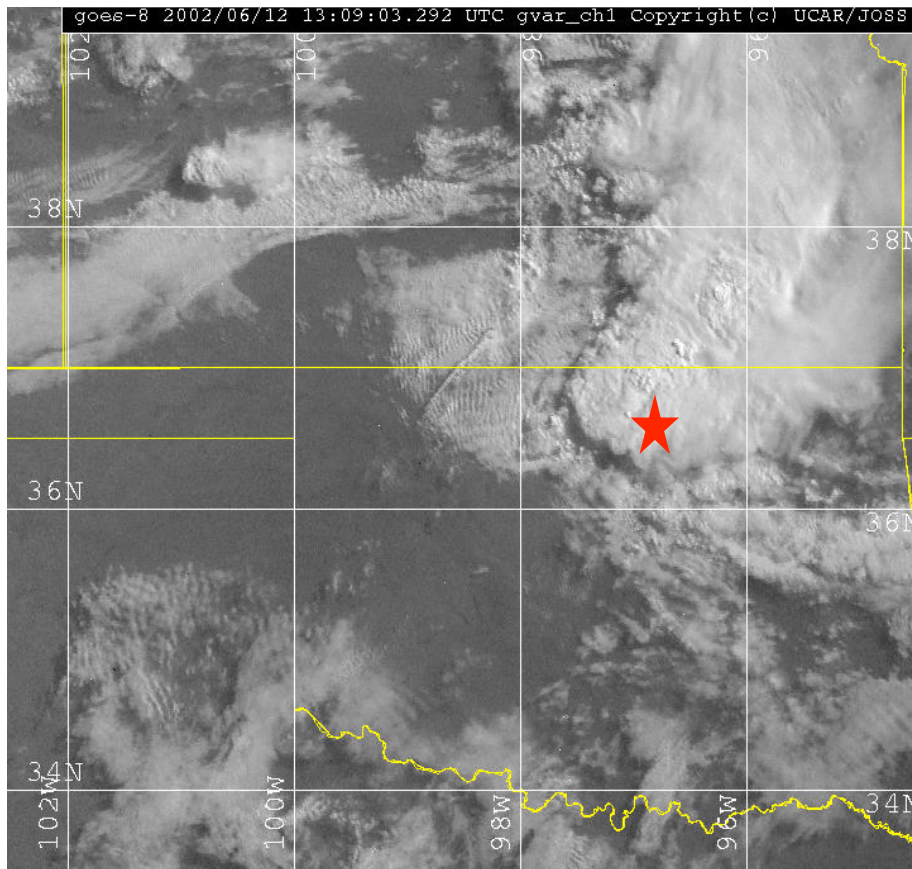

GOES IR satellite image of central US on left with location of GPS station shown as red star. Time series of temperature, dew point, wind speed, and accumulated rain shown in top right. GPS PW is shown in bottom right. Increase in PW of more than 20mm due to convective system shown in satellite image.

P549 Position residuals

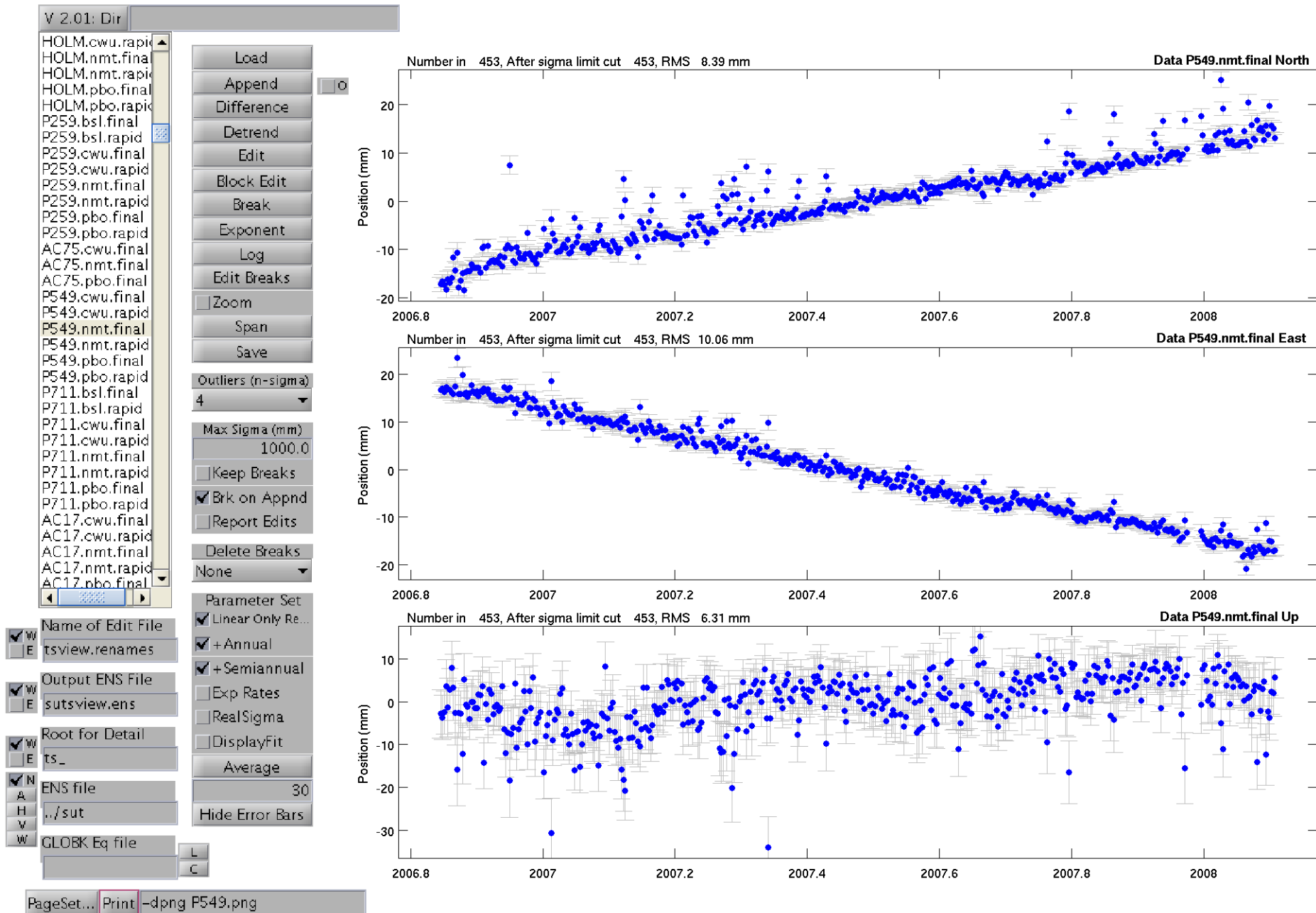



Location of P549 (Google Earth)



lat 34.601978°

lon -119.324928°

elev 1307 m

Aug 14, 2006

Eye alt 3.52 km

Water Vapor as a Proxy for Pressure in Storm Prediction

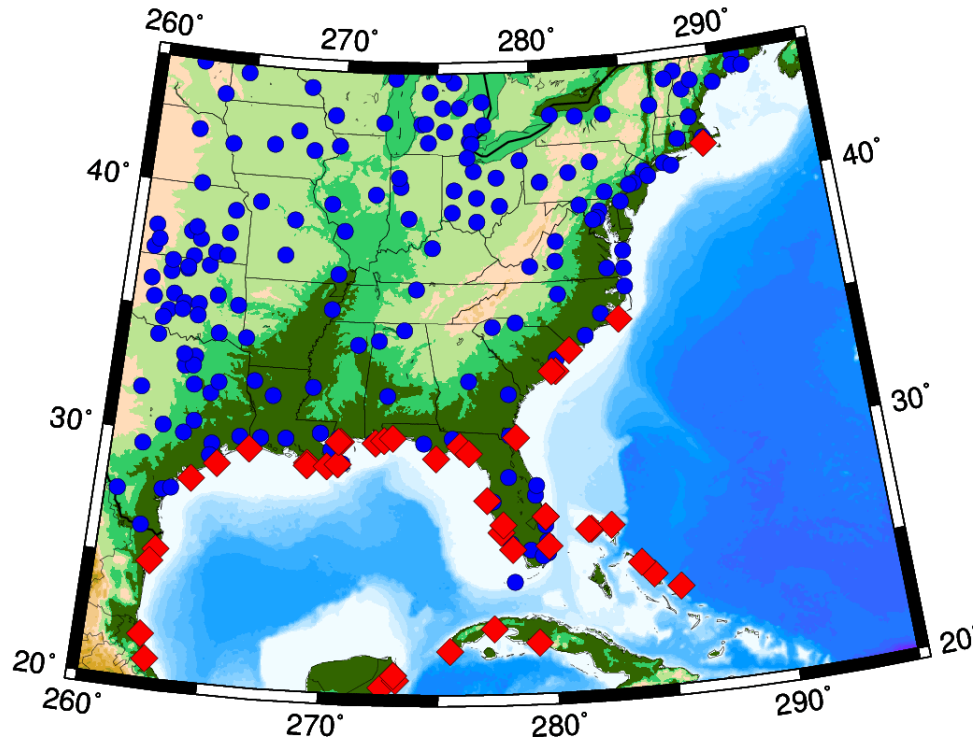

GPS stations (blue) and locations of hurricane landfalls

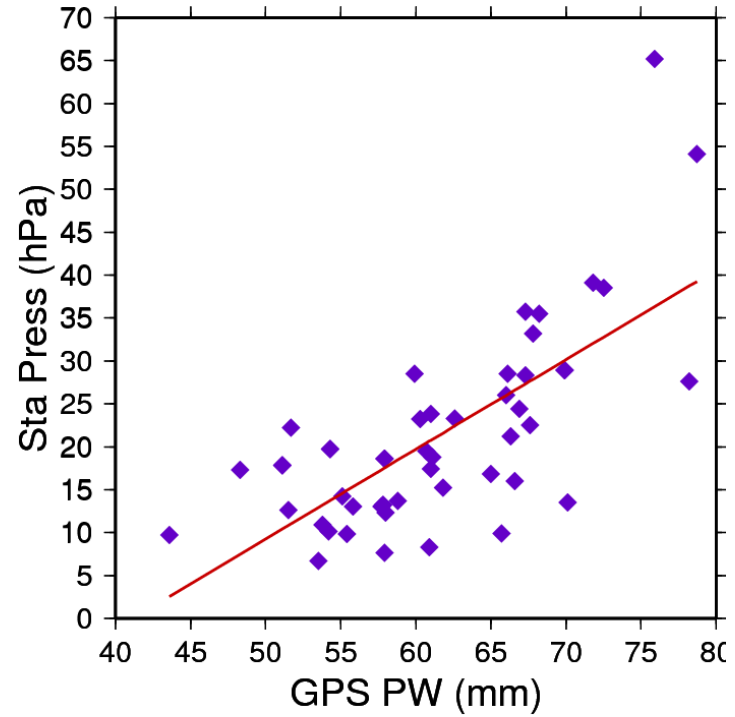

Correlation (75%) between GPS-measured precipitable water and drop in surface pressure for stations within 200 km of landfall.

Effect of the Neutral Atmosphere on GPS Measurements

Slant delay = (Zenith Hydrostatic Delay) * (“Dry” Mapping Function) +
(Zenith Wet Delay) * (Wet Mapping Function) +
(Gradient Delay NS) (Gradient Mapping Function) * Cos/Sin(Azimuth)

- To recover the water vapor (ZWD) for meteorological studies, you must have a very accurate measure of the hydrostatic delay (ZHD) from a barometer at the site.
- For height studies, a less accurate model for the ZHD is acceptable, but still important because the wet and dry mapping functions are different (see next slides)
- The mapping functions used can also be important for low elevation angles
- For both a priori ZHD and mapping functions, you have a choice in GAMIT of using values computed at 6-hr intervals from numerical weather models (VMF1 grids) or an analytical fit to 20-years of VMF1 values, GPT and GMF (defaults)

Mapping function effects

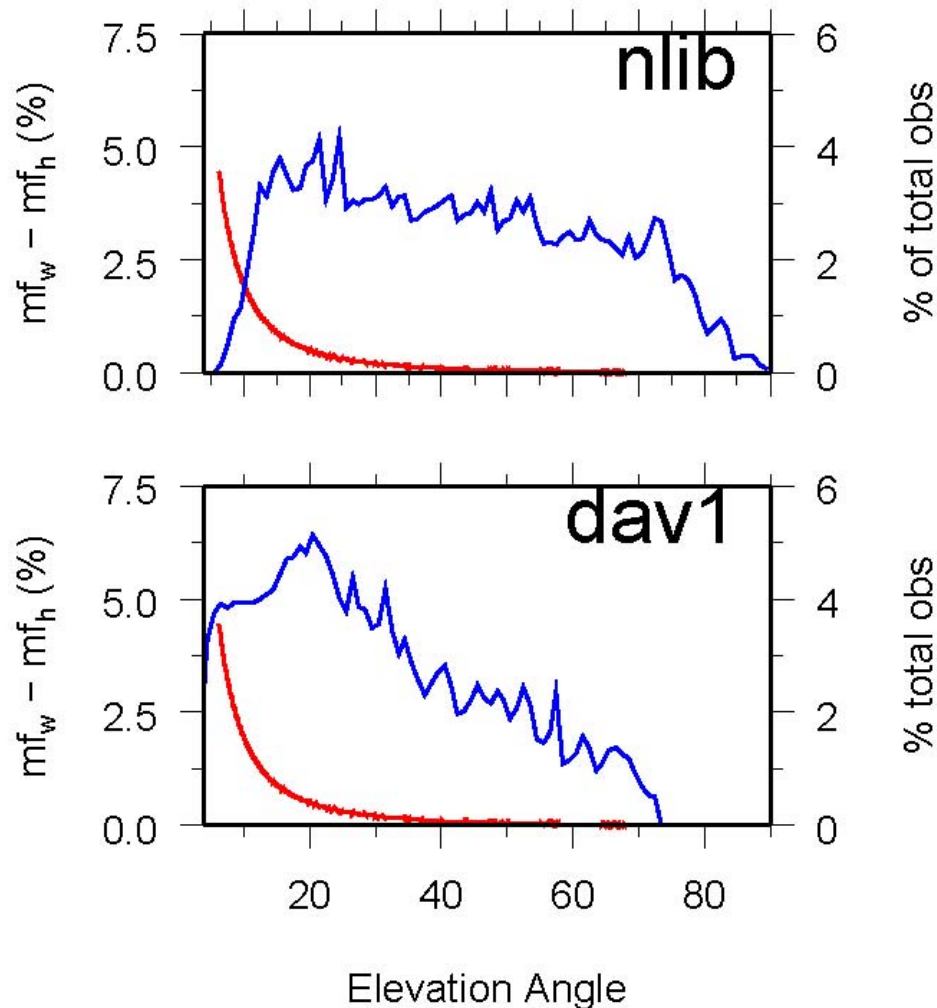

- Mapping functions differ and this means hydrostatic and wet delays are coupled in the estimation.
- Example: Percent difference (red) between hydrostatic and wet mapping functions for a high latitude (dav1) and mid-latitude site (nlib). Blue shows percentage of observations at each elevation angle. From Tregoning and Herring [2006].

Effect of surface pressure errors

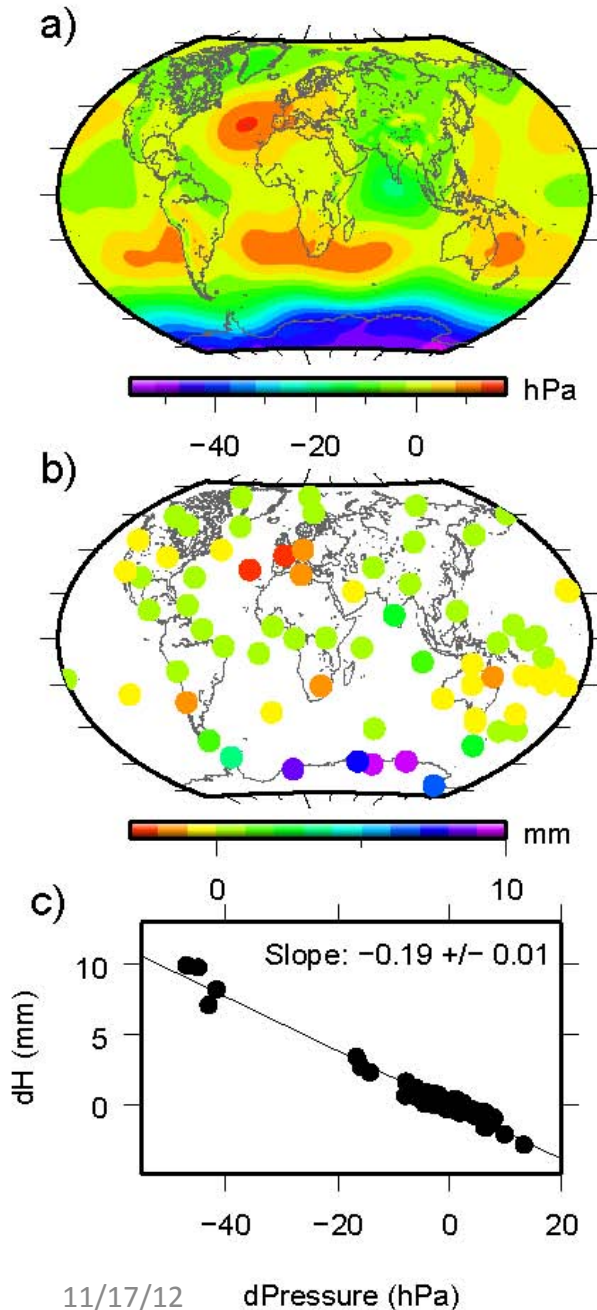

a) surface pressure derived from “standard” sea level pressure and the mean surface pressure derived from the GPT model.

b) station heights using the two sources of a priori pressure.

c) Relation between a priori pressure differences and height differences. Elevation-dependent weighting was used in the GPS analysis with a minimum elevation angle of 7 deg.

Short-period Variations in Surface Pressure not Modeled by GPT

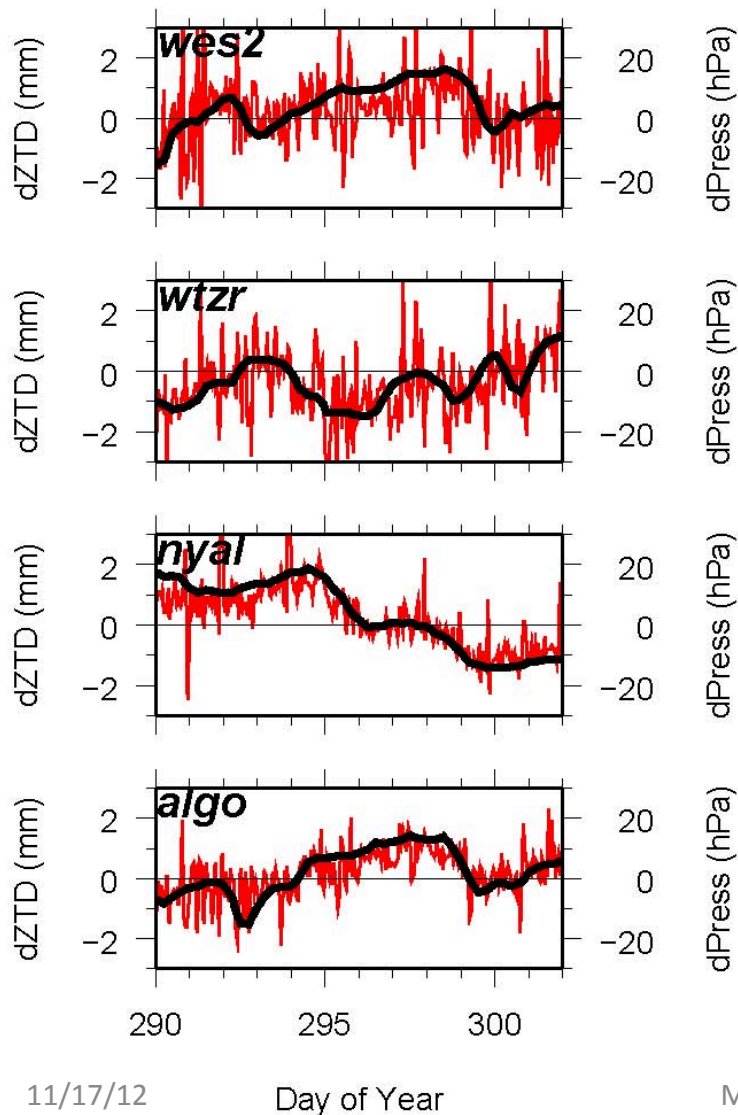

- Differences in GPS estimates of ZTD at Algonquin, Ny Alessund, Wettzell and Westford computed using static or observed surface pressure to derive the a priori. Height differences will be about twice as large. (Elevation-dependent weighting used).

Annual Component of Vertical Loading

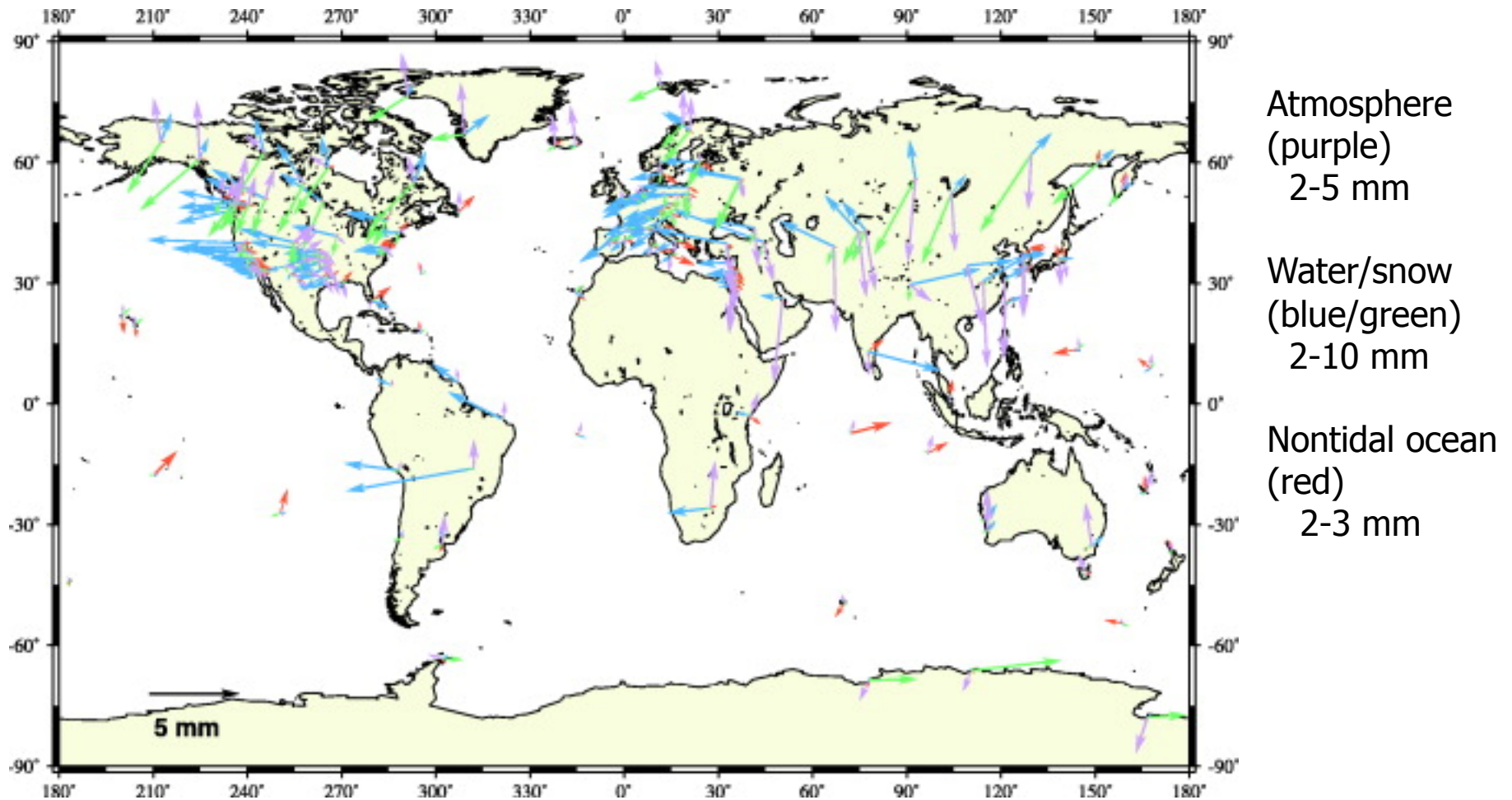

From Dong et al. *J. Geophys. Res.*, 107, 2075, 2002

Atmospheric pressure loading near equator

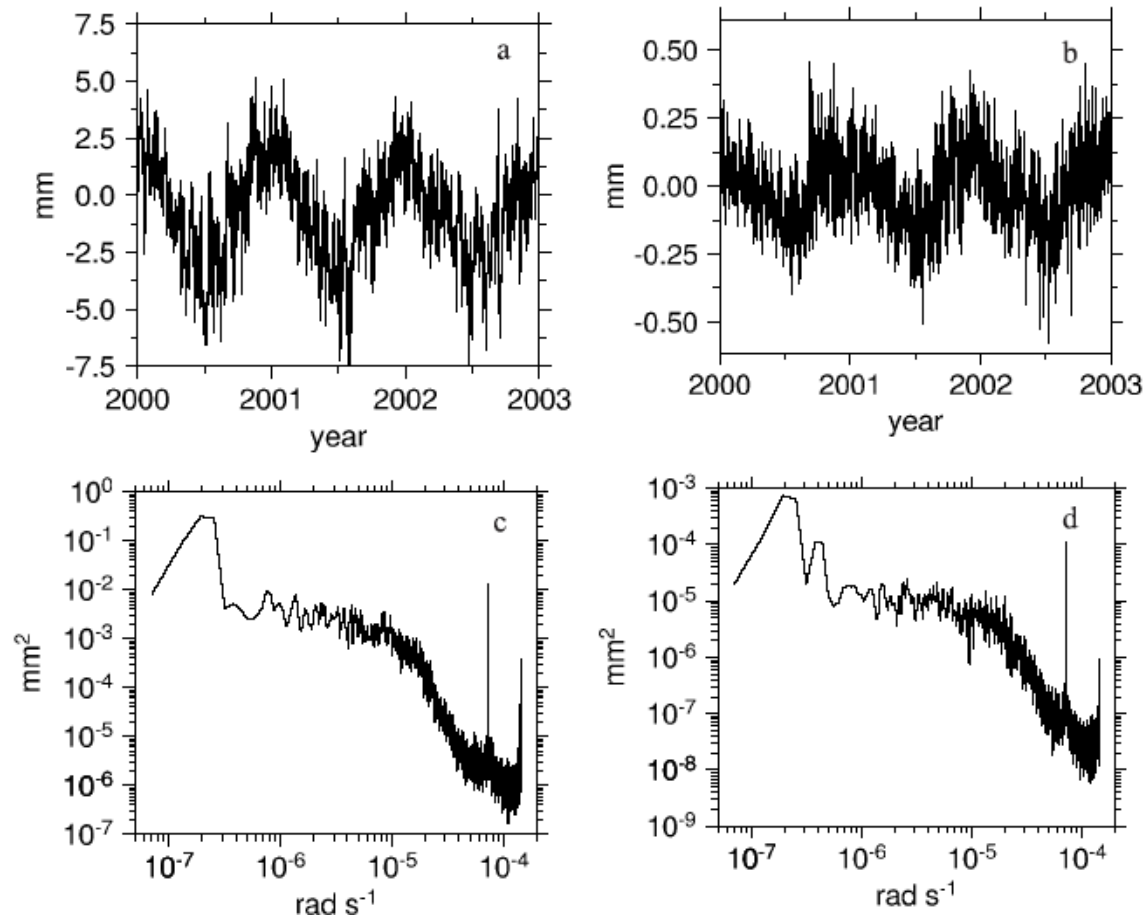

Vertical (a) and north (b) displacements from pressure loading at a site in South Africa. Bottom is power spectrum. Dominant signal is annual. From *Petrov and Boy (2004)*

Atmospheric pressure loading at mid-latitudes

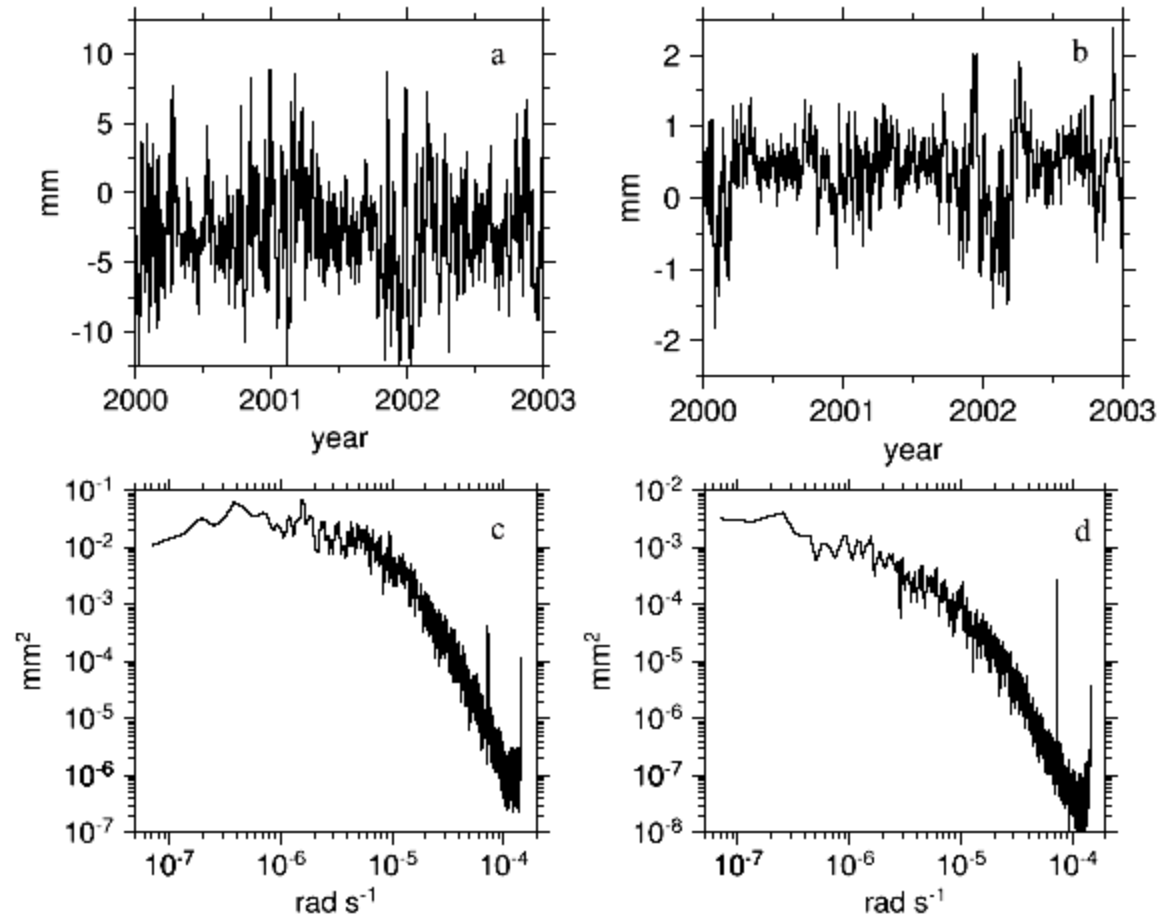

Vertical (a) and north (b) displacements from pressure loading at a site in Germany. Bottom is power spectrum. Dominant signal is short-period.

Atmospheric delay correlation

- Spatial and temporal autocorrelation of atmospheric pressure loading (functions for mid-latitude site Algonquin, Canada).

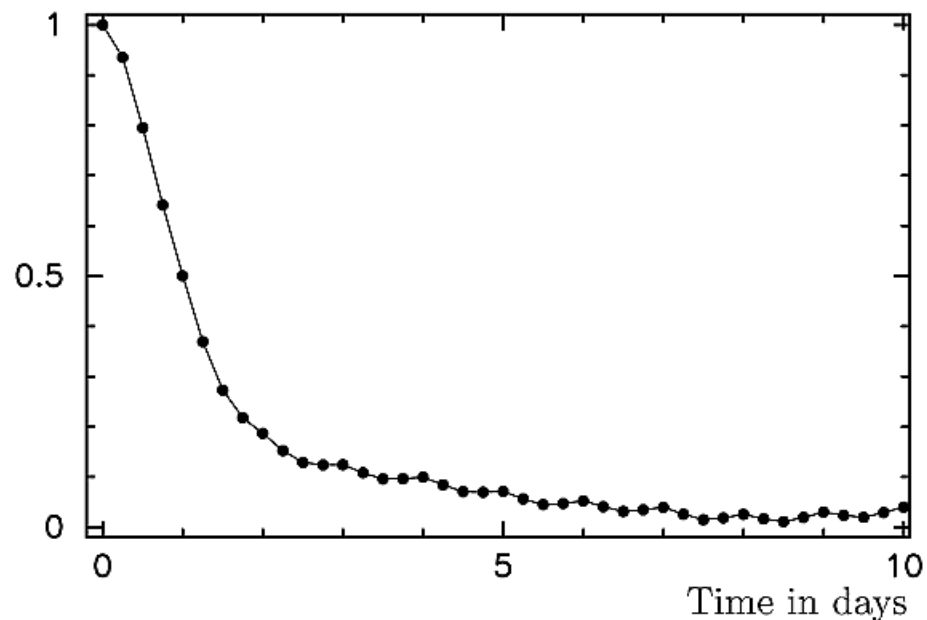
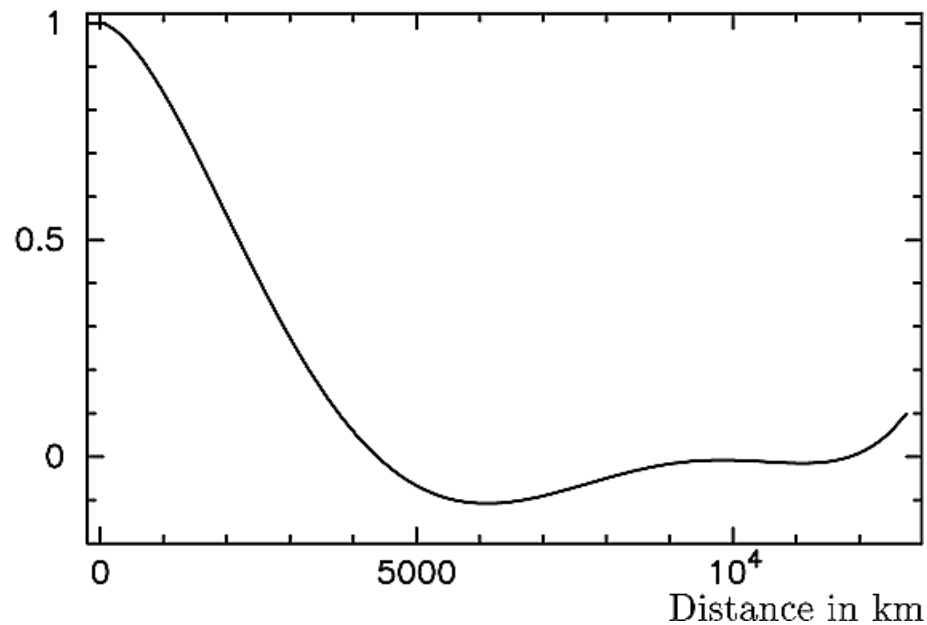

From Petrov and Boy, *J. Geophys. Res.*, 109, B03405, 2004

GAMIT Options for Modeling the Troposphere and Loading

- For height studies, the most accurate models for a priori ZHD and mapping functions are the VMF1 grids computed from numerical weather models at 6-hr intervals.
- For most applications it is sufficient to use the analytical models for a priori ZHD (GPT) and mapping functions (GMF) fit to 20 years of VMF1.
- For meteorological studies, you need to use surface pressure measured at the site to compute the wet delay, but this can be applied after the data processing (sh_met_util), and it is sufficient to use GPT in the GAMIT processing
- For height studies, atmospheric loading from numerical weather models (ATML grids) should also be applied. (ZHD and ATML are correlated, so don't use one set of grids without the other)

Summary

- For individual locations in regional network, atmospheric delay modeling, multipath and the stability of monumentation are usually the largest error contributors
- For survey mode measurements, set-up errors can also be large
- The other largest uncertainty and the way results are viewed can arise from the reference frame realization.